



VARTA SILVER dynamic AGM

Vehicle Key Benefits



Патентована PowerFrame® решетка за надеждна стартова мощност, бързо зареждане и устойчивост на корозия

For more information visit varta-automotive.com

ORDER INFORMATION

European Type No. (ETN):	595901085
Article Number:	595901085J382
Short Code:	A5
Barcode:	4016987165539
UK Code:	019AGM
Packaging Unit:	1
Quantity per Pallet:	36

TECHNICAL INFORMATION

Voltage [V]:	12	Base Hold-down:	B13
Battery Capacity [Ah]:	95	Layout:	0
CCA, EN [A]:	850	Terminal Types:	1
Length [mm]:	353	Case Size:	H8/LN5
Width [mm]:	175	Weight filled (kg):	26,4
Height [mm]:	190		

DRAWINGS

B13

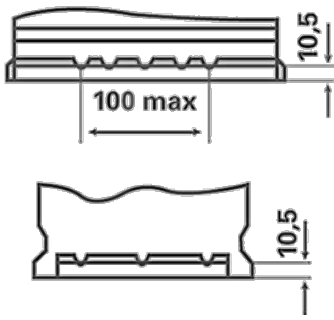

0

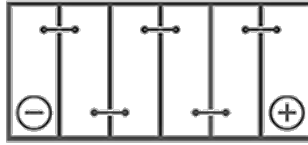

1

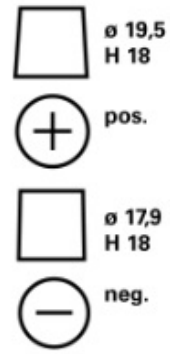

3

