



## VARTA SILVER dynamic AGM

### Beneficiul cheii vehiculului



Pregătit pentru xEV – asigurând siguranța și fiabilitatea pentru toate cerințele actuale și viitoare ale vehiculelor



Cele mai bune performanțe start-stop pentru o economie maximă de combustibil - pentru că sistemul start-stop poate fi utilizat la maxim.



90% reciclat – o baterie VARTA AGM nou produsă este compusă în proporție de 90% din plumb reciclat.



OE - garanția că bateria de schimb are aceeași calitate ca și bateria de primă echipare (echipare originală)



Tehnologia grilei PowerFrame® este patentată pentru o putere de pornire sigură, pentru o reîncărcare rapidă și pentru rezistență la coroziune.

Pentru mai multe informații vizitați [varta-automotive.com](http://varta-automotive.com)

### INFORMAȚII REFERITOARE LA COMANDĂ

ETN:	595901085
Numar articol:	595901085J382
Short Code:	A5
Codul bară:	4016987165539
UK Code:	019AGM
Unitatea de ambalare:	1
Paletă:	36

### INFORMAȚII TEHNICE

Tensiune [V]:	12	Base Hold-down:	B13
Acumulator [Ah]:	95	Aspect:	0
Curent electric test-la-rece, EN [A]:	850	Tipuri de terminale:	1
Lungime [mm]:	353	Dimensiunea carcasei:	H8/LN5
Latime [mm]:	175	Greutatea (gol):	26,4
Înălțime [mm]:	190		

# DESENE TEHNICE

**B13**

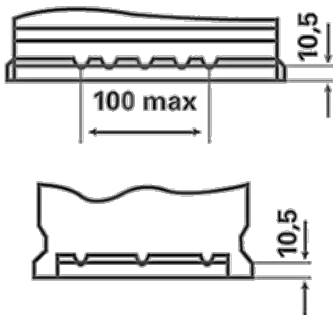

**0**

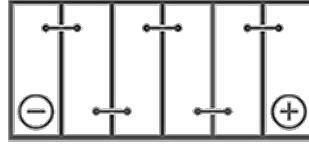

**1**



**3**

