



VARTA SILVER dynamic AGM

Køretøjets nøglefordel



xEV ready – sikrer sikkerhed og pålidelighed til alle nuværende og fremtidige bilbehov



Optimal start-/stopydelse og maksimal brændstofføkonomi – da start-/stopsystemet kan anvendes så tit som muligt



90 % genbrug – 90 % af et nyproduceret VARTA AGM-batteri består af genindvundet bly



Originale reservedele sikrer, at udskiftningsbatteriet har samme kvalitet som det originale



Patenteret PowerFrame® giver til pålidelig startstrøm, hurtig opladning og korrosionsmodstand.

For mere information besøg varta-automotive.com

BESTILLINGSINFORMATION

ETN:	580901080
Artikel nummer:	580901080J382
Kort kode:	A6
Stregkode:	4016987165522
UK kode:	115AGM
Emballageenhed:	1
Antal pr. palle:	36

TEKNISKE INFORMATIONER

Spænding [V]:	12	Base Hold-down:	B13
Batterikapacitet [Ah]:	80	Layout:	0
Koldstartsstrøm [A]:	800	Poltype:	1
Længde [mm]:	315	Kabinetstørrelse:	H7/LN4
Bredde [mm]:	175	Vægt (tom):	22,76
Højde [mm]:	190		

B13

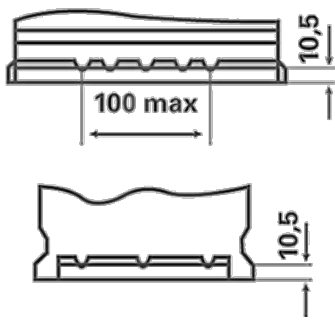

0



1

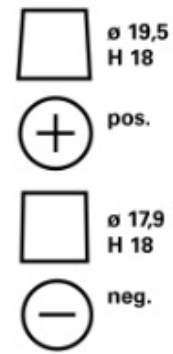

3

