



## KØRETØJETS NØGLEFORDEL



### Start og stopp

Egnet til basale Start-Stopp systemer.



### Tysk fremstilling

Designet til at opfylde de højeste tyske standarder.



### Patenteret PowerFrame<sup>®</sup>

Patenteret PowerFrame<sup>®</sup> giver til pålidelig startstrøm, hurtig opladning og korrosionsmodstand.



### Originale kriterier

Tåler betydelig dybdeafledning

# BLUE DYNAMIC EFB

595500085D842

## TEKNISKE INFORMATIONER

Batterikapacitet:	<b>95 Ah</b>	Koldstartsstrøm:	<b>850 A</b>
Spænding:	<b>12 V</b>	Dimensioner (L/B/H):	<b>353/175/190</b>
Kabinetstørrelse:	<b>H8/LN5</b>	Kort kode:	<b>N95</b>
UK kode:	<b>019EFB</b>	ETN:	<b>595500085</b>
Vægt (tom):	<b>24,49 kg</b>	Bund fastholdelse:	<b>B13</b>

## TEGNINGER

**B13**

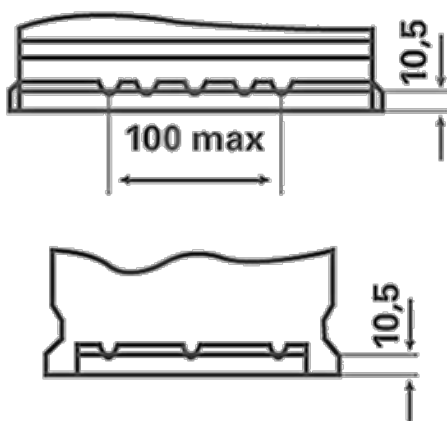

**0**

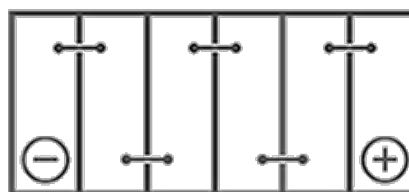

**1**



**3**

