



## VARTA SILVER dynamic AGM

### Køretøjets nøglefordel



xEV ready – sikrer sikkerhed og pålidelighed til alle nuværende og fremtidige bilbehov



Optimal start-/stopydelse og maksimal brændstoføkonomi – da start-/stopsystemet kan anvendes så tit som muligt



90 % genbrug – 90 % af et nyproduceret VARTA AGM-batteri består af genindvundet bly



Originale reservedele sikrer, at udskiftningsbatteriet har samme kvalitet som det originale



Patenteret PowerFrame® giver til pålidelig startstrøm, hurtig opladning og korrosionsmodstand.

For mere information besøg [varta-automotive.com](http://varta-automotive.com)

### BESTILLINGSINFORMATION

ETN:	605901095
Artikel nummer:	605901095J382
Kort kode:	A4
Stregkode:	4016987165546
UK kode:	020AGM
Emballageenhed:	1
Antal pr. palle:	36

### TEKNISKE INFORMATIONER

Spænding [V]:	12	Base Hold-down:	B13
Batterikapacitet [Ah]:	105	Layout:	0
Koldstartsstrøm [A]:	950	Poltype:	1
Længde [mm]:	394	Kabinetstørrelse:	H9/LN6
Bredde [mm]:	175	Vægt (tom):	29,4
Højde [mm]:	190		

**B13**

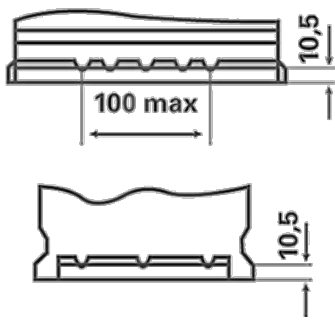

**0**



**1**

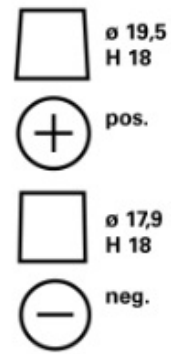

**3**

