



**For motorhomes, caravans and boats with highest energy demands.**

The new Professional Li-Ion battery is designed to power electrical equipment for a home-like living experience. It's improved Depth of Discharge (DoD) delivers even more usable energy and consistent performance. The fast recharge allows it to be back to 100% within 2-3 hours. At the same time, the significantly reduced weight and size make it easy to handle and install. Inbuilt cell heating function and the high protection class guarantee that the Professional Li-Ion battery operates effectively and reliably even under demanding conditions. The special App ensures you stay informed via bluetooth on battery state of charge, overall health, cycles & usage, internal temperature, current and alarms for all BMS functions. VARTA batteries deliver precision performance and lasting reliability.

**VEHICLE KEY BENEFITS**



**20x cycle life**

20x cycle life compared with a conventional lead acid battery.



**Lightweight**

Twice the usable energy with 55%\* weight saving compared to advanced conventional lead acid batteries (\*H8/L5 with 100 Ah).



**Smart connect**

Smart connection options such as Bluetooth or CAN bus.



**Serial and parallel connection**

Capable for series and parallel connection.



**Heating function**

Low temperature variants with cell heating function.



**Protection class IP67 (50Ah - IP54)**

VARTA batteries come with high water and dust ingress protection ratings, ensuring durability and reliability even in harsh environments.



**Designed in Germany**

Precision design for outstanding performance and customer experience.



**Maintenance-free**

Maintenance-free battery designed to deliver dependable performance for your vehicle.

# PROFESSIONAL LI-ION

# 850150001K31A

## TECHNICAL DATA

Capacity:	<b>150 Ah</b>	CCA:	-
Voltage:	<b>12,8 V</b>	Dimensions (L/W/H):	<b>353/175/190</b>
Case Size:	<b>H8/L5</b>	Short Code:	<b>LL150LT</b>
UK-Code:	<b>019LIO</b>	ETN:	<b>850150001</b>
Weight filled:	<b>17 kg</b>	Base Hold-down:	<b>B13</b>
Layout:	<b>0</b>	Terminal Type:	<b>1</b>

## DRAWINGS

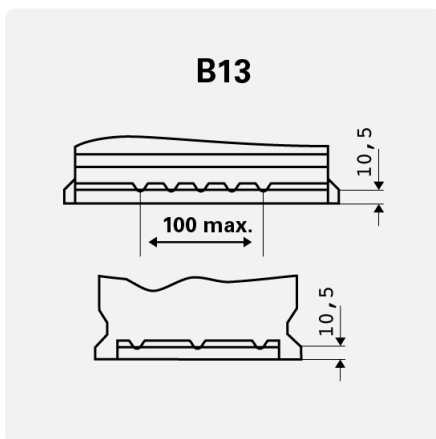

Base Hold-down

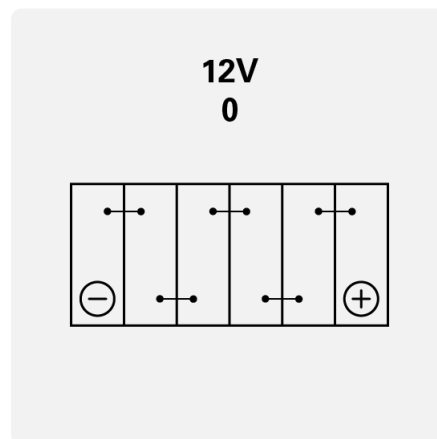

Layout

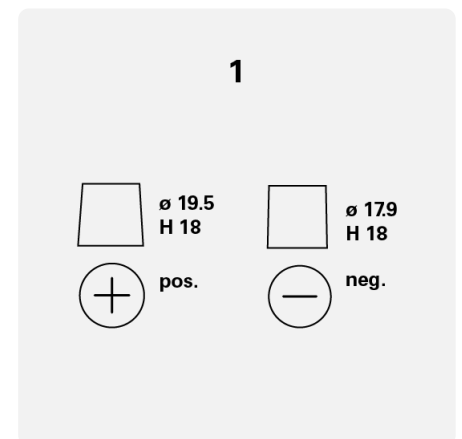

Terminal Type