



SILVER DYNAMIC AGM

570901076J382



SILVER DYNAMIC AGM

570901076J382

TECHNICAL DATA

Capacity:	70 Ah	CCA:	760 A
Voltage:	12 V	Dimensions (L/W/H):	278/175/190
Case Size:	H6/LN3	Short Code:	A7
UK-Code:	096AGM	ETN:	570901076
Weight filled:	20,4 kg	Base Hold-down:	B13

DRAWINGS

B13

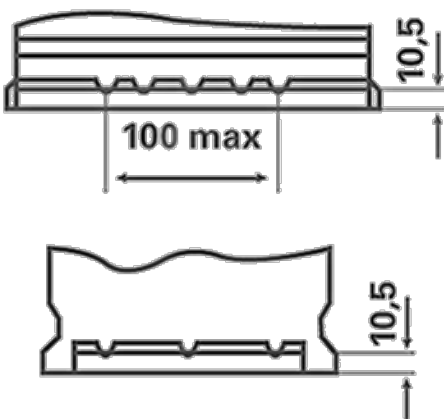

0



1



3

