







### FORDELEN MED NØKKELEN

	<b>xEV-klar</b>	xEV-klar – sørger for sikkerhet og pålitelighet i alle nåværende og fremtidige bilbehov
	<b>Start Stopp</b>	Beste start/stopp-ytelse for optimal drivstofføkonomi – siden start/stopp-systemet kan brukes så ofte som mulig
	<b>Resirkulering</b>	90 % resirkulert – 90 % av et nyprodusert VARTAAGM-batteri består av resirkulert bly
	<b>Opprinnelige reservedeler</b>	Originale reservedeler sørger for at det nye batteriet holder samme kvalitet som det opprinnelige
	<b>Patentert PowerFrame®</b>	Patentert PowerFrame® gitter for pålitelig startkraft, rask oppladning og korrosjonsbestandighet.

# SILVER DYNAMIC AGM

# 570901076J382

## TEKNISK INFORMASJON

Batterikapasitet:	<b>70 Ah</b>	Kaldstartstrøm EN:	<b>760 A</b>
Spenning:	<b>12 V</b>	Dimensjoner (L/B/H):	<b>278/175/190</b>
Størrelse på hus:	<b>H6/LN3</b>	Short Code:	<b>A7</b>
UK-Code:	<b>096AGM</b>	ETN:	<b>570901076</b>
Vekt [tomt]:	<b>20,4 kg</b>	Base hold-down:	<b>B13</b>

## TEGNINGER

**B13**

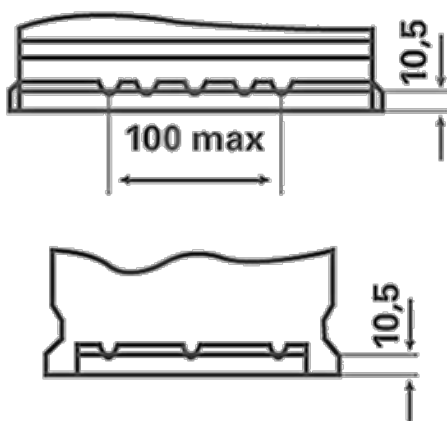

**0**

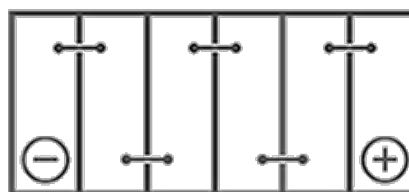

**1**



**3**

