







FORDELEN MED NØKKELEN

	xEV-klar	xEV-klar – sørger for sikkerhet og pålitelighet i alle nåværende og fremtidige bilbehov
	Start Stopp	Beste start/stopp-ytelse for optimal drivstofføkonomi – siden start/stopp-systemet kan brukes så ofte som mulig
	Resirkulering	90 % resirkulert – 90 % av et nyprodusert VARTAAGM-batteri består av resirkulert bly
	Opprinnelige reservedeler	Originale reservedeler sørger for at det nye batteriet holder samme kvalitet som det opprinnelige
	Patentert PowerFrame®	Patentert PowerFrame® gitter for pålitelig startkraft, rask oppladning og korrosjonsbestandighet.

SILVER DYNAMIC AGM

595901085J382

TEKNISK INFORMASJON

Batterikapasitet:	95 Ah	Kaldstartstrøm EN:	850 A
Spenning:	12 V	Dimensjoner (L/B/H):	353/175/190
Størrelse på hus:	H8/LN5	Short Code:	A5
UK-Code:	019AGM	ETN:	595901085
Vekt [tomt]:	26,4 kg	Base hold-down:	B13

TEGNINGER

B13

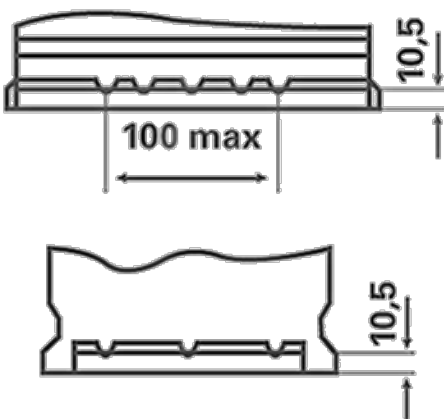

0



1



3

