



## VARTA SILVER dynamic

### Principais benefícios da bateria



Desenvolvida segundo os mais elevados padrões alemães.



Para uma potência de arranque fiável, carregamento rápido e resistência à corrosão.



Bateria fabricada de acordo com os padrões e especificações do fabricante original (OE)

Para mais informações visite [varta-automotive.pt](http://varta-automotive.pt)

### INFORMAÇÃO DA ORDEM DE COMPRA





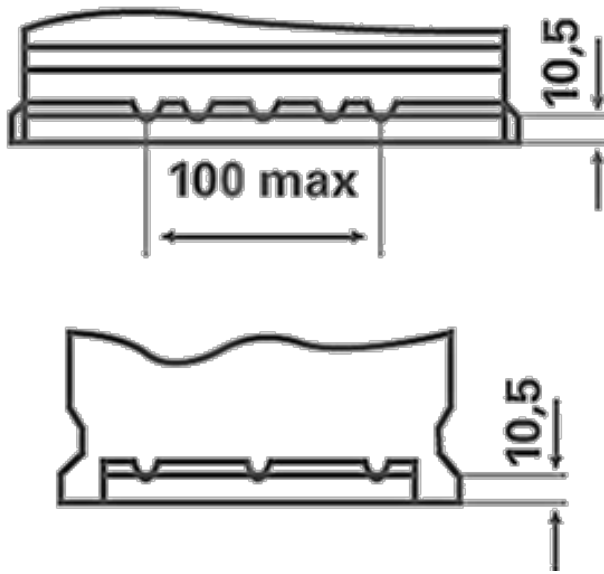

Código Europeu (ETN):	563401061
Nº artigo:	5634010613162
Referência Comercial:	D39
Código de barras:	4016987119761
Referência UK:	077
Unidades por embalagem:	1
Palete ou caixa:	63

### INFORMAÇÕES TÉCNICAS

Tensão [V]:	12	Base Hold-down:	B13
Capacidade da bateria [Ah]:	63	Layout:	1
Corrente de ensaio a frio EN [A]:	610	Tipos de terminais:	1
Comprimento [mm]:	242	Tamanho da caixa:	H5R/LN2R
Largura [mm]:	175	Peso (sem líquido):	14,78
Altura [mm]:	190		

# B13

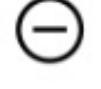

<b>1</b>		<b>3</b>	
	ø 19,5 H 18		ø 14,7 H 18
	pos.		pos.
	ø 17,9 H 18		ø 13,1 H 18
	neg.		neg.